



8N70

8A N-Channel Power MOSFET

Features

- New technology for high voltage device
- Low on-resistance and low conduction losses
- Small package
- Ultra Low Gate Charge cause lower driving requirements
- 100% Avalanche Tested
- ROHS compliant

Mechanical Data

Case : TO-220AB

Terminals : Solder plated, solderable per MIL-STD-750, Method 2026

Polarity : As marked

Mounting Position : Any

TO-220AB

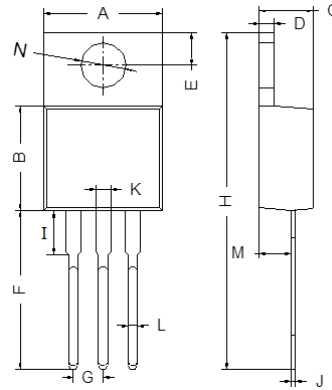

TO-220AB		
Dim	Min	Max
A	9.80	10.30
B	8.30	8.90
C	4.37	4.77
D	1.10	1.45
E	2.62	2.87
F	13.14	13.74
G	2.41	2.67
H	28.40	29.16
I	3.55	4.05
J	0.35	0.58
K	1.20	1.32
L	0.68	0.94
M	2.40	2.60
N	3.71	3.91

All Dimensions in mm

Application

- Power factor correction (PFC)
- Switched mode power supplies(SMPS)
- Uninterruptible Power Supply (UPS)

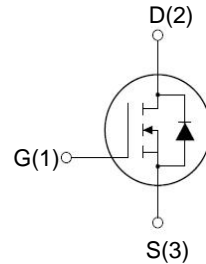
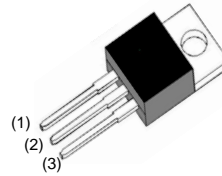

Maximum Ratings And Electrical Characteristics

Ratings at 25°C ambient temperature unless otherwise specified. Single phase half-wave 60Hz, resistive or inductive load, for capacitive load current derate by 20%.

Table 1. Absolute Maximum Ratings (T_c=25°C)

Parameter	Symbol	8N70	Unit
Drain-Source Voltage (V _{GS} =0V)	V _{DS}	700	V
Gate-Source Voltage (V _{DS} =0V) AC (f>1 Hz)	V _{GS}	±30	V
Continuous Drain Current at T _c =25°C	I _{D(DC)}	8	A
Continuous Drain Current at T _c =100°C	I _{D(DC)}	5.2	A
Pulsed drain current (Note 1)	I _{DM(pluse)}	32	A
Maximum Power Dissipation(T _c =25°C)	P _D	69	W
Derate above 25°C		0.55	W/°C
Single pulse avalanche energy (Note 2)	E _{AS}	156	mJ
Avalanche current (Note 1)	I _{AR}	1.7	A
Repetitive Avalanche energy , t _{AR} limited by T _{Jmax} (Note 1)	E _{AR}	0.3	mJ



®

Parameter	Symbol	8N70	Unit
Drain Source voltage slope, $V_{DS} \leq 480 V$,	dv/dt	50	V/ns
Reverse diode dv/dt, $V_{DS} \leq 480 V, I_{SD} < I_D$	dv/dt	15	V/ns
Operating Junction and Storage Temperature Range	T_J, T_{STG}	-55...+150	°C

* limited by maximum junction temperature

Table 2. Thermal Characteristic

Parameter	Symbol	8N70	Unit
Thermal Resistance, Junction-to-Case (Maximum)	R_{thJC}	1.81	°C /W
Thermal Resistance, Junction-to-Ambient (Maximum)	R_{thJA}	62	°C /W

Table 3. Electrical Characteristics (TA=25°C unless otherwise noted)

Parameter	Symbol	Condition	Min	Typ	Max	Unit
On/off states						
Drain-Source Breakdown Voltage	BV_{DSS}	$V_{GS}=0V, I_D=250\mu A$	700			V
Zero Gate Voltage Drain Current($T_C=25^\circ C$)	I_{DSS}	$V_{DS}=700V, V_{GS}=0V$			1	μA
Zero Gate Voltage Drain Current($T_C=125^\circ C$)	I_{DSS}	$V_{DS}=700V, V_{GS}=0V$			100	μA
Gate-Body Leakage Current	I_{GSS}	$V_{GS}=\pm 20V, V_{DS}=0V$			± 100	nA
Gate Threshold Voltage	$V_{GS(th)}$	$V_{DS}=V_{GS}, I_D=250\mu A$	3		4	V
Drain-Source On-State Resistance	$R_{DS(on)}$	$V_{GS}=10V, I_D=4A$		540	600	m Ω
Dynamic Characteristics						
Input Capacitance	C_{iss}	$V_{DS}=50V, V_{GS}=0V,$ $F=1.0MHz$		590		pF
Output Capacitance	C_{oss}			37		pF
Reverse Transfer Capacitance	C_{rss}			0.9		pF
Total Gate Charge	Q_g	$V_{DS}=480V, I_D=8A,$ $V_{GS}=10V$		14.6	22	nC
Gate-Source Charge	Q_{gs}			4		nC
Gate-Drain Charge	Q_{gd}			6.7		nC
Switching times						
Turn-on Delay Time	$t_{d(on)}$	$V_{DD}=420V, I_D=4A,$ $R_G=4.7\Omega, V_{GS}=10V$		9		nS
Turn-on Rise Time	t_r			6.5		nS
Turn-Off Delay Time	$t_{d(off)}$			61		nS
Turn-Off Fall Time	t_f			10		nS
Source- Drain Diode Characteristics						
Source-drain current(Body Diode)	I_{SD}	$T_C=25^\circ C$			8	A
Pulsed Source-drain current(Body Diode)	I_{SDM}				32	A
Forward On Voltage	V_{SD}	$T_J=25^\circ C, I_{SD}=8A, V_{GS}=0V$		0.9	1.2	V
Reverse Recovery Time	t_{rr}	$T_J=25^\circ C, I_F=4A, di/dt=100A/\mu s$		230		nS
Reverse Recovery Charge	Q_{rr}			1.2		μC
Peak Reverse Recovery Current	I_{rrm}			10.5		A

Notes 1.Repetitive Rating: Pulse width limited by maximum junction temperature

2. $T_J=25^\circ C, V_{DD}=50V, V_G=10V, R_G=25\Omega$



TYPICAL ELECTRICAL AND THERMAL CHARACTERISTICS (curves) 8N70

Figure1. Safe operating area

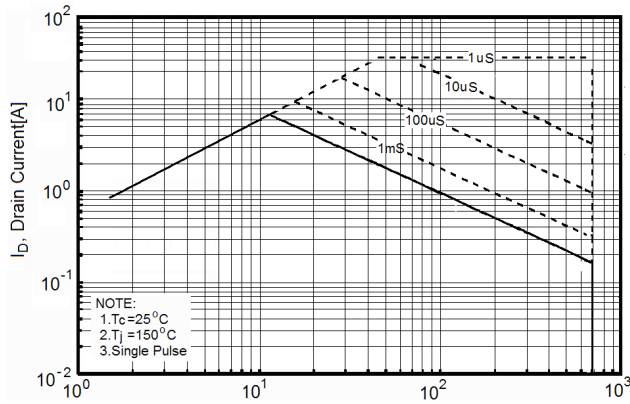

Figure2. Source-Drain Diode Forward Voltage

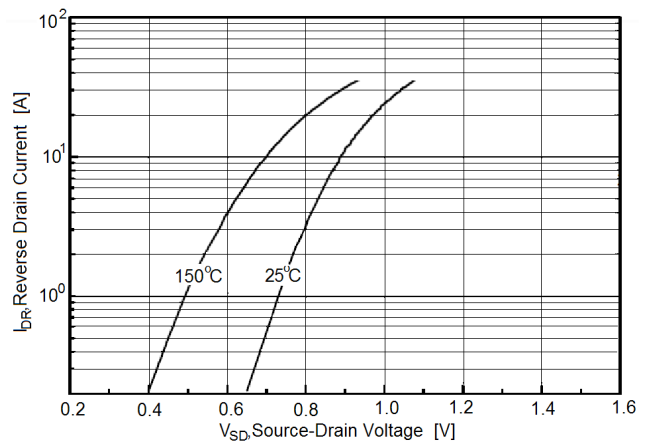

Figure3. Output characteristics

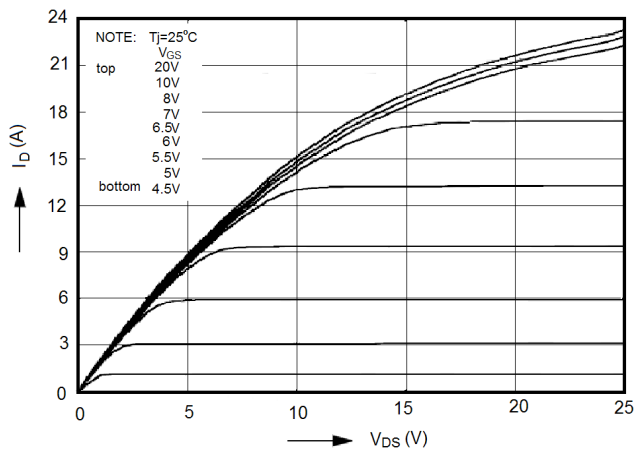

Figure4. Transfer characteristics

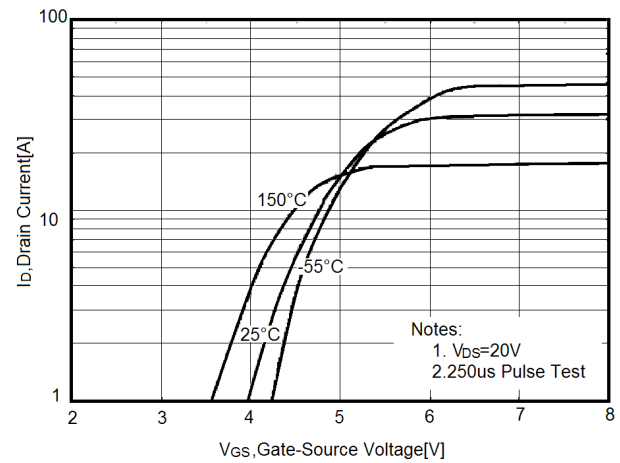
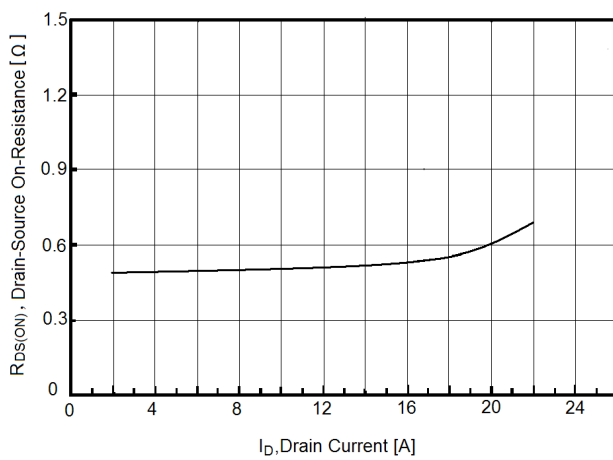

Figure5. Static drain-source on resistance





TYPICAL ELECTRICAL AND THERMAL CHARACTERISTICS (curves) 8N70

Figure6. $R_{DS(ON)}$ vs Junction Temperature

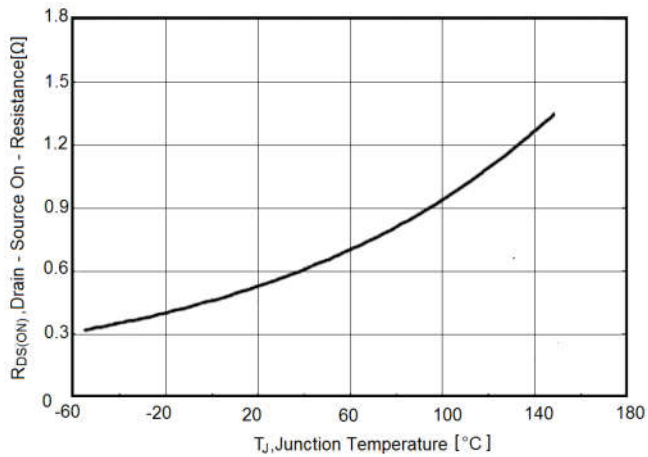

Figure7. BV_{DSS} vs Junction Temperature

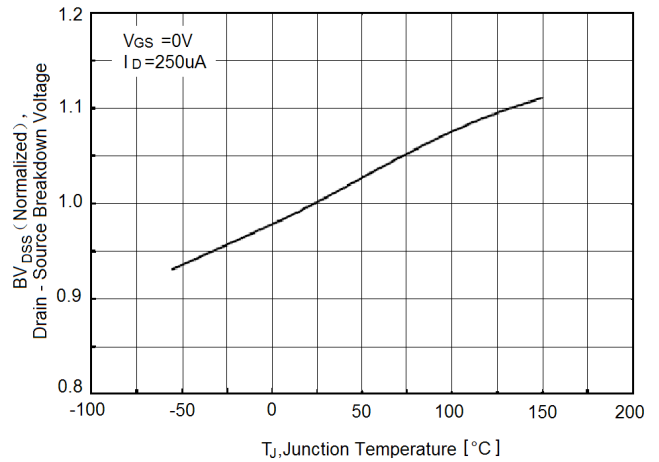

Figure8. Maximum I_D vs Junction Temperature

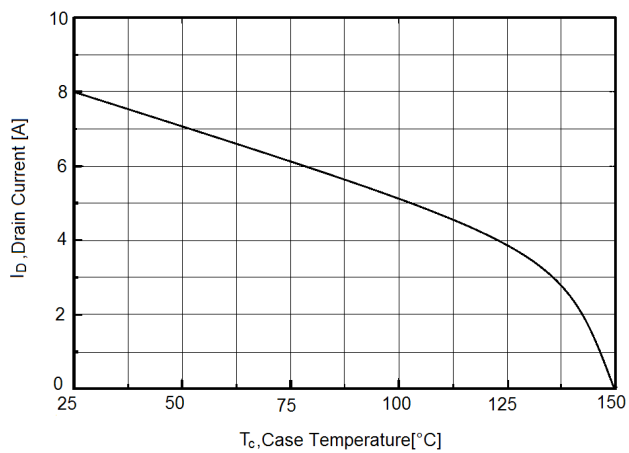

Figure9. Capacitance

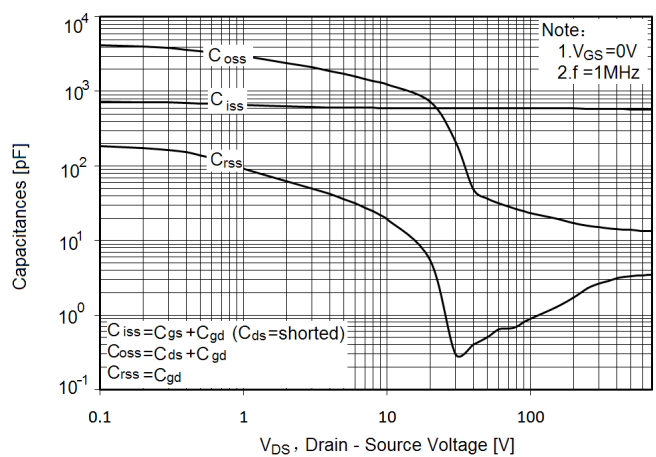

Figure10. Gate charge waveforms

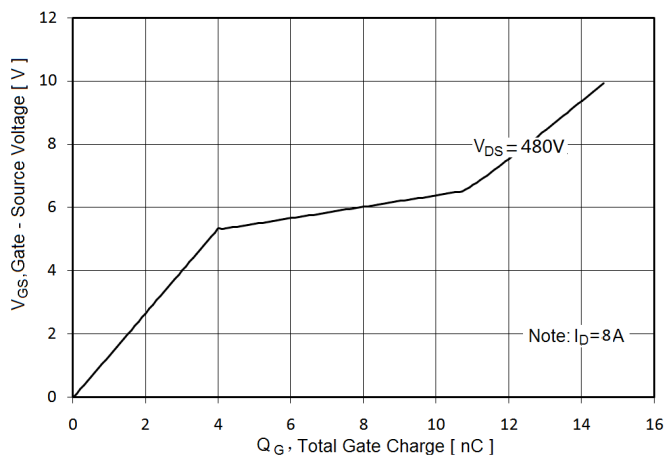

Figure11. Transient Thermal Impedance

