



SF10A01F THRU SF10A06F

SUPER FAST RECTIFIERS

Reverse Voltage - 100 to 600 Volts Forward Current - 10.0 Amperes

FEATURES

- Low cost.
- Low leakage.
- Low forward voltage drop.
- High current capability.
- Easily cleaned with Alcohol, Isopropanol and Similar solvents.
- The plastic material carries U/L recognition 94V-0

MECHANICAL DATA

- Case: TO-220F-2L
- Molding Compound: UL Flammability Classification Rating 94V-0
- Terminals: Matte tin-plated leads; solderability-per MIL-STD-202, Method 208

TO-220F-2L

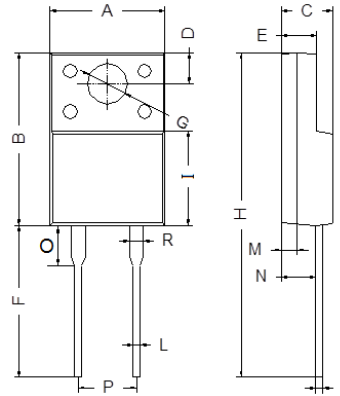

TO-220F-2L		
Dim	Min	Max
A	9.80	10.30
B	15.20	15.80
C	4.37	4.77
D	2.90	3.30
E	2.50	2.90
F	12.90	13.50
G	3.10	3.30
H	28.40	29.16
I	8.40	9.10
J	0.35	0.58
L	0.68	0.94
M	1.30	1.50
N	2.40	2.60
O	2.60	3.10
P	4.98	5.18
R	1.10	1.32

All Dimensions in mm

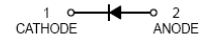

Maximum Ratings and Electrical Characteristics @ $T_A=25^{\circ}\text{C}$ unless otherwise specified

Single Phase, half wave, 60Hz, resistive or inductive load.
For capacitive load, derate current by 20%.

Characteristic	Symbol	SF10 A01F	SF10 A02F	SF10 A03F	SF10 A04F	SF10 A05	SF10 A06F	Unit
Peak Repetitive Reverse Voltage	V_{RRM}							V
Working Peak Reverse Voltage	V_{RWM}	100	200	300	400	500	600	
DC Blocking Voltage	V_R							
RMS Reverse Voltage	$V_{R(RMS)}$	70	140	210	280	350	420	V
Average Rectified Output Current @ $T_C = 100^{\circ}\text{C}$	$I_{(AV)}$	10.0						A
Non-Repetitive Peak Forward Surge Current 8.3ms Single half sine-wave superimposed on rated load (JEDEC Method)	I_{FSM}	100						A
Forward Voltage @ $I_F = 10.0\text{A}$	V_F	1.0		1.3		1.7		V
Peak Reverse Current @ $T_A = 25^{\circ}\text{C}$ At Rated DC Blocking Voltage @ $T_A = 100^{\circ}\text{C}$	I_{RM}	10.0 250						μA
Reverse Recovery Time (Note 1)	t_{rr}	35						nS
Typical Junction Capacitance (Note 2)	C_j	65						pF
Operating and Storage Temperature Range	T_j, T_{STG}	-55 to +150						$^{\circ}\text{C}$

Note: 1. Measured with $I_F = 0.5\text{A}$, $I_R = 1.0\text{A}$, $I_{RR} = 0.25\text{A}$.
2. Measured at 1.0 MHz and applied reverse voltage of 4.0V D.C.



Ratings and Characteristics Curves (@ $T_A = 25^\circ\text{C}$ unless otherwise specified)

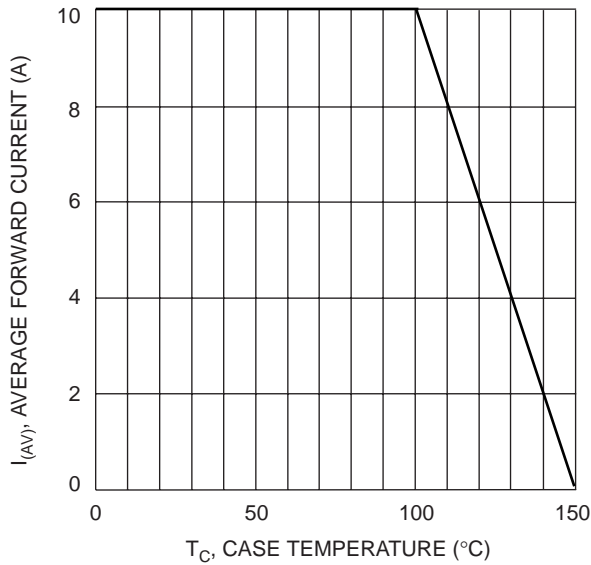

Fig. 1 Forward Current Derating Curve

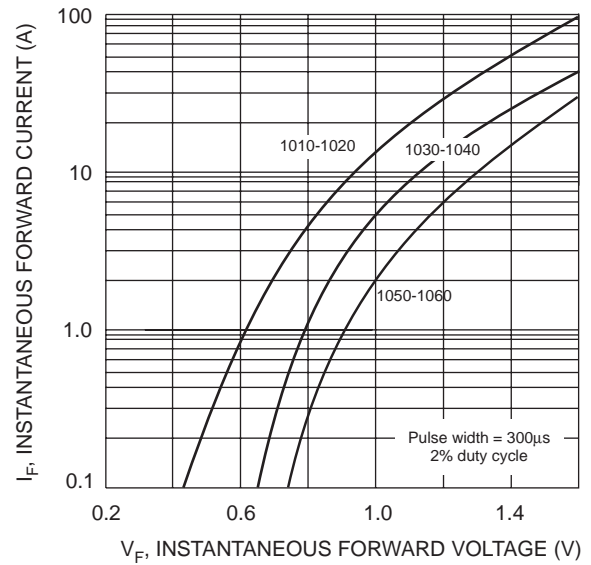

Fig. 2 Typical Forward Characteristics

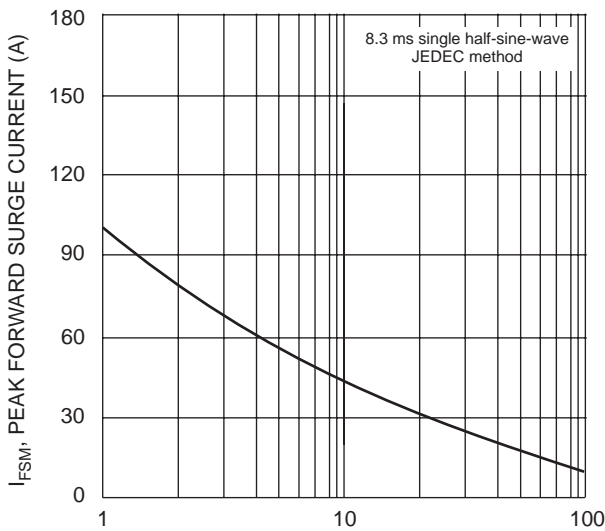

Fig. 3 Max Non-Repetitive Surge Current

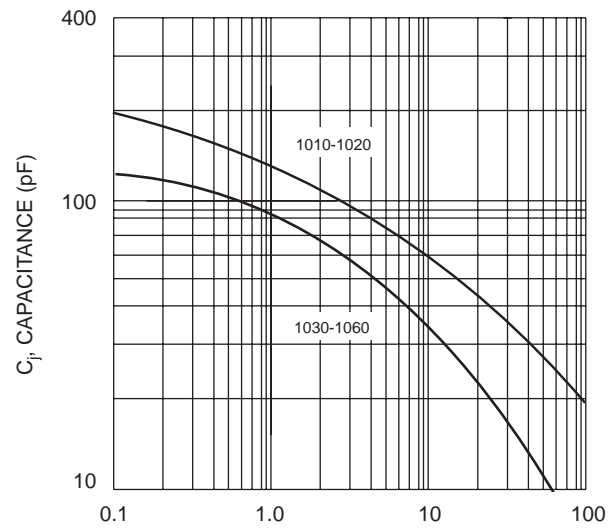
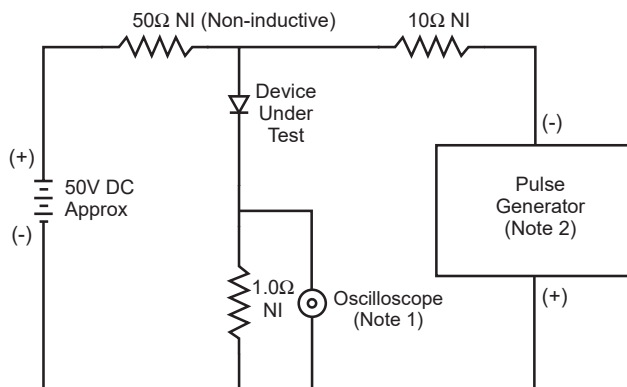

Fig. 4 Typical Junction Capacitance



Notes:

1. Rise Time = 7.0ns max. Input Impedance = 1.0MΩ, 22pF.
2. Rise Time = 10ns max. Input Impedance = 50Ω.

Fig. 5 Reverse Recovery Time Characteristic and Test Circuit

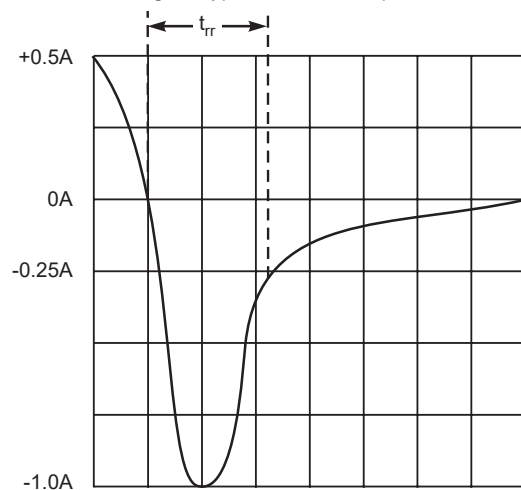

Set time base for 5/10ns/cm