



ES3ABF THRU ES3JBF

SURFACE MOUNT SUPER FAST RECTIFIER

Reverse Voltage - 50 to 600 Volts Forward Current - 3.0 Ampere

FEATURES

The plastic package carries Underwriters Laboratory Flammability Classification 94V-0
 For surface mounted applications
 Super fast switching for high efficiency
 Low reverse leakage
 Built-in strain relief, ideal for automated placement
 High forward surge current capability
 High temperature soldering guaranteed:
 260°C/10 seconds at terminals
 Glass passivated chip junction

MECHANICAL DATA

Case: JEDEC SMBF molded plastic body over passivated chip
Terminals: Solder plated, solderable per MIL-STD-750, Method 2026
Polarity: Color band denotes cathode end
Mounting Position: Any
Weight: 0.0018 ounce, 0.05 grams

SMBF

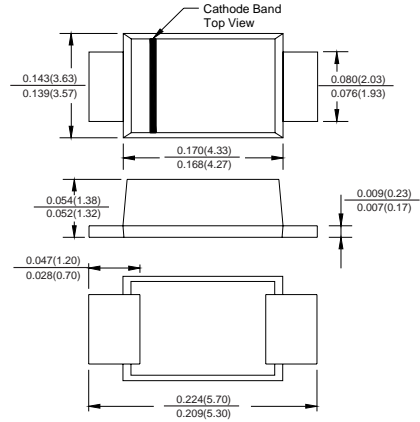

Dimensions in inches and (millimeters)

MAXIMUM RATINGS AND ELECTRICAL CHARACTERISTICS

Ratings at 25°C ambient temperature unless otherwise specified.
 Single phase half wave 60Hz, resistive or inductive load, for capacitive load current derate by 20%.

	SYMBOLS	ES3ABF	ES3BBF	ES3CBF	ES3DBF	ES3EBF	ES3GBF	ES3JBF	UNITS
Maximum repetitive peak reverse voltage	V_{RRM}	50	100	150	200	300	400	600	VOLTS
Maximum RMS voltage	V_{RMS}	35	70	105	140	210	280	420	VOLTS
Maximum DC blocking voltage	V_{DC}	50	100	150	200	300	400	600	VOLTS
Maximum average forward rectified current at $T_L=100.^\circ\text{C}$	$I_{(AV)}$	3.0							Amp
Peak forward surge current 8.3ms single half sine-wave superimposed on rated load (JEDEC Method)	I_{FSM}	100							Amps
Maximum instantaneous forward voltage at 3.0A	V_F	0.95			1.25		1.7		Volts
Maximum DC reverse current $T_A=25^\circ\text{C}$ at rated DC blocking voltage $T_A=125^\circ\text{C}$	I_R				5.0				μA
					150.0				
Maximum reverse recovery time (NOTE 1)	t_{rr}				35				ns
Typical junction capacitance (NOTE 2)	C_J				62.0				pF
Typical thermal resistance (NOTE 3)	$R_{\theta JA}$				38.0				$^\circ\text{C/W}$
Operating junction and storage temperature range	T_J, T_{STG}				-55 to +150				$^\circ\text{C}$

Note: 1. Reverse recovery condition $I_F=0.5\text{A}, I_R=1.0\text{A}, I_{rr}=0.25\text{A}$
 2. Measured at 1MHz and applied reverse voltage of 4.0V D.C.
 3. P.C.B. mounted with 0.2x0.2" (5.0x5.0mm) copper pad areas



RATINGS AND CHARACTERISTIC CURVES ES3ABF THRU ES3JBF

AVERAGE FORWARD RECTIFIED CURRENT, AMPERES

FIG. 1- FORWARD CURRENT DERATING CURVE

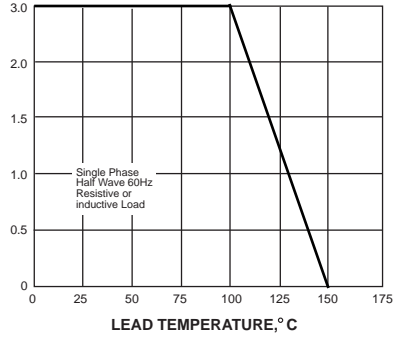

PEAK FORWARD SURGE CURRENT, AMPERES

FIG. 2-MAXIMUM NON-REPETITIVE PEAK FORWARD SURGE CURRENT

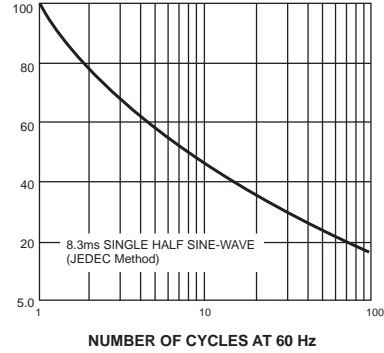

INSTANTANEOUS FORWARD CURRENT, AMPERES

FIG. 3-TYPICAL INSTANTANEOUS FORWARD CHARACTERISTICS

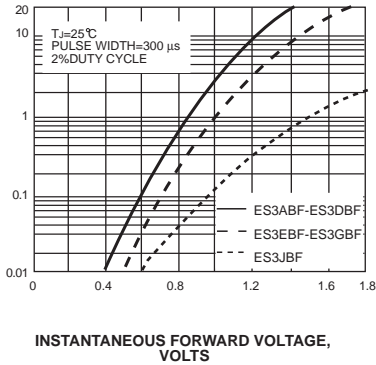

INSTANTANEOUS REVERSE CURRENT, MICROAMPERES

FIG. 4-TYPICAL REVERSE CHARACTERISTICS

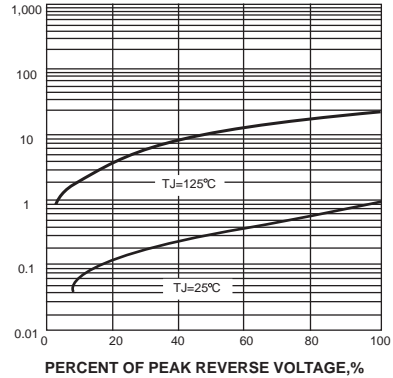

JUNCTION CAPACITANCE, pF

FIG. 5-TYPICAL JUNCTION CAPACITANCE

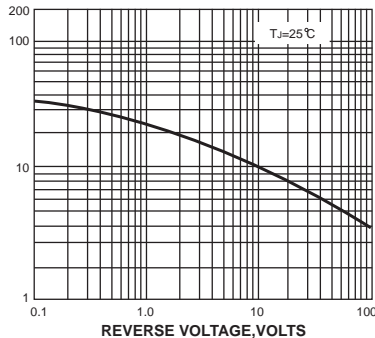

TRANSIENT THERMAL IMPEDANCE, °C/W

FIG. 6-TYPICAL TRANSIENT THERMAL IMPEDANCE

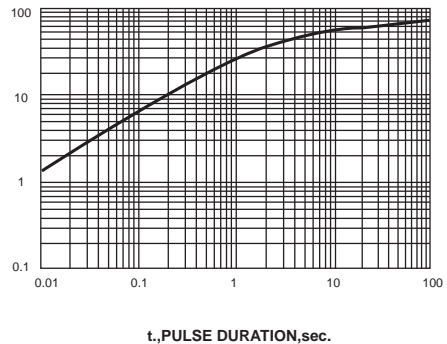

t., PULSE DURATION, sec.